

*Phase leg  
Series & parallel diodes  
MOSFET Power Module*

$$V_{DSS} = 1000V$$

$$R_{DSon} = 230m\Omega \text{ typ @ } T_j = 25^\circ C$$

$$I_D = 36A \text{ @ } T_c = 25^\circ C$$

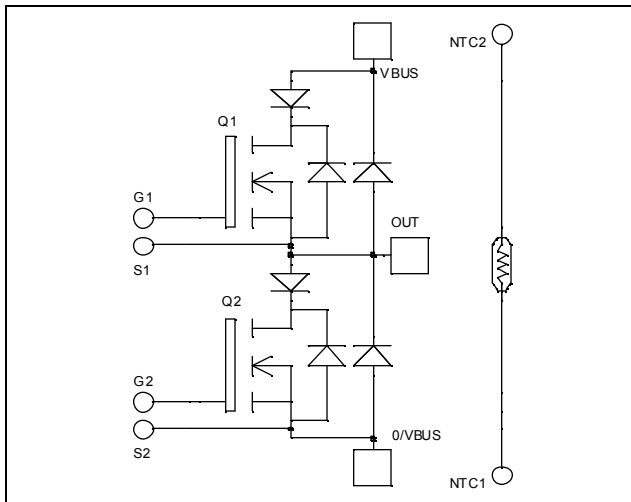

### Application

- Motor control
- Switched Mode Power Supplies
- Uninterruptible Power Supplies

### Features

- Power MOS 7<sup>®</sup> MOSFETs
  - Low  $R_{DSon}$
  - Low input and Miller capacitance
  - Low gate charge
  - Avalanche energy rated
  - Very rugged
- Kelvin source for easy drive
- Very low stray inductance
  - Symmetrical design
  - Lead frames for power connections
- Internal thermistor for temperature monitoring
- High level of integration

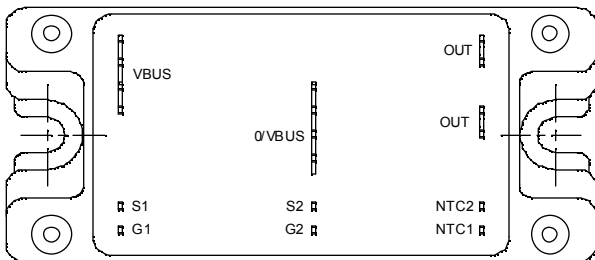

### Benefits

- Outstanding performance at high frequency operation
- Direct mounting to heatsink (isolated package)
- Low junction to case thermal resistance
- Solderable terminals both for power and signal for easy PCB mounting
- Low profile
- RoHS Compliant

### Absolute maximum ratings

Symbol	Parameter	Max ratings	Unit
$V_{DSS}$	Drain - Source Breakdown Voltage	1000	V
$I_D$	Continuous Drain Current	$T_c = 25^\circ C$	36
		$T_c = 80^\circ C$	27
$I_{DM}$	Pulsed Drain current	144	
$V_{GS}$	Gate - Source Voltage	$\pm 30$	V
$R_{DSon}$	Drain - Source ON Resistance	270	$m\Omega$
$P_D$	Maximum Power Dissipation	$T_c = 25^\circ C$	694
$I_{AR}$	Avalanche current (repetitive and non repetitive)	18	A
$E_{AR}$	Repetitive Avalanche Energy	50	mJ
$E_{AS}$	Single Pulse Avalanche Energy	2500	

**CAUTION:** These Devices are sensitive to Electrostatic Discharge. Proper Handling Procedures Should Be Followed. See application note APT0502 on [www.microsemi.com](http://www.microsemi.com)

All ratings @  $T_j = 25^\circ\text{C}$  unless otherwise specified

**Electrical Characteristics**

Symbol	Characteristic	Test Conditions	Min	Typ	Max	Unit
$I_{DSS}$	Zero Gate Voltage Drain Current	$V_{GS} = 0V, V_{DS} = 1000V$			200	$\mu\text{A}$
		$V_{GS} = 0V, V_{DS} = 800V$			1000	
$R_{DS(on)}$	Drain – Source on Resistance	$V_{GS} = 10V, I_D = 18A$		230	270	$\text{m}\Omega$
$V_{GS(th)}$	Gate Threshold Voltage	$V_{GS} = V_{DS}, I_D = 5\text{mA}$	3		5	V
$I_{GSS}$	Gate – Source Leakage Current	$V_{GS} = \pm 30V, V_{DS} = 0V$			$\pm 150$	nA

**Dynamic Characteristics**

Symbol	Characteristic	Test Conditions	Min	Typ	Max	Unit
$C_{iss}$	Input Capacitance	$V_{GS} = 0V$		8700		pF
$C_{oss}$	Output Capacitance	$V_{DS} = 25V$		1430		
$C_{rss}$	Reverse Transfer Capacitance	$f = 1\text{MHz}$		240		
$Q_g$	Total gate Charge	$V_{GS} = 10V$ $V_{Bus} = 500V$ $I_D = 36A$		308		nC
$Q_{gs}$	Gate – Source Charge			52		
$Q_{gd}$	Gate – Drain Charge			194		
$T_{d(on)}$	Turn-on Delay Time	<b>Inductive switching @ <math>125^\circ\text{C}</math></b> $V_{GS} = 15V$ $V_{Bus} = 667V$ $I_D = 36A$ $R_G = 2.5\Omega$		10		ns
$T_r$	Rise Time			12		
$T_{d(off)}$	Turn-off Delay Time			121		
$T_f$	Fall Time			35		
$E_{on}$	Turn-on Switching Energy	<b>Inductive switching @ <math>25^\circ\text{C}</math></b> $V_{GS} = 15V, V_{Bus} = 667V$ $I_D = 36A, R_G = 2.5\Omega$		1278		$\mu\text{J}$
$E_{off}$	Turn-off Switching Energy			760		
$E_{on}$	Turn-on Switching Energy	<b>Inductive switching @ <math>125^\circ\text{C}</math></b> $V_{GS} = 15V, V_{Bus} = 667V$ $I_D = 36A, R_G = 2.5\Omega$		2092		$\mu\text{J}$
$E_{off}$	Turn-off Switching Energy			902		

**Series diode ratings and characteristics**

Symbol	Characteristic	Test Conditions	Min	Typ	Max	Unit
$V_{RRM}$	Maximum Peak Repetitive Reverse Voltage		200			V
$I_{RM}$	Maximum Reverse Leakage Current	$V_R = 200V$	$T_j = 25^\circ\text{C}$		350	$\mu\text{A}$
			$T_j = 125^\circ\text{C}$		600	
$I_F$	DC Forward Current			60		A
$V_F$	Diode Forward Voltage	$I_F = 60A$		1.1	1.15	V
		$I_F = 120A$		1.4		
		$I_F = 60A$	$T_j = 125^\circ\text{C}$	0.9		
$t_{rr}$	Reverse Recovery Time	$I_F = 60A$ $V_R = 133V$ $di/dt = 400A/\mu\text{s}$	$T_j = 25^\circ\text{C}$	24		ns
			$T_j = 125^\circ\text{C}$	48		
$Q_{rr}$	Reverse Recovery Charge	$I_F = 60A$ $V_R = 133V$ $di/dt = 400A/\mu\text{s}$	$T_j = 25^\circ\text{C}$	66		nC
			$T_j = 125^\circ\text{C}$	300		

**Parallel diode ratings and characteristics**

Symbol	Characteristic	Test Conditions		Min	Typ	Max	Unit
V <sub>RRM</sub>	Maximum Peak Repetitive Reverse Voltage			1000			V
I <sub>RM</sub>	Maximum Reverse Leakage Current	V <sub>R</sub> =1000V	T <sub>j</sub> = 25°C			350	μA
			T <sub>j</sub> = 125°C			600	
I <sub>F</sub>	DC Forward Current	T <sub>c</sub> = 65°C			60		A
V <sub>F</sub>	Diode Forward Voltage	I <sub>F</sub> = 60A			1.9	2.3	V
		I <sub>F</sub> = 120A			2.2		
		I <sub>F</sub> = 60A	T <sub>j</sub> = 125°C		1.7		
t <sub>rr</sub>	Reverse Recovery Time	I <sub>F</sub> = 60A V <sub>R</sub> = 667V	T <sub>j</sub> = 25°C		290		ns
			T <sub>j</sub> = 125°C		390		
Q <sub>rr</sub>	Reverse Recovery Charge	di/dt = 400A/μs	T <sub>j</sub> = 25°C		1340		nC
			T <sub>j</sub> = 125°C		4700		

**Thermal and package characteristics**

Symbol	Characteristic	Min	Typ	Max	Unit	
R <sub>thJC</sub>	Junction to Case Thermal Resistance	Transistor			0.18	°C/W
		Diode			0.65	
V <sub>ISOL</sub>	RMS Isolation Voltage, any terminal to case t=1 min, I <sub>isol</sub> <1mA, 50/60Hz	2500			V	
T <sub>J</sub>	Operating junction temperature range	-40		150	°C	
T <sub>STG</sub>	Storage Temperature Range	-40		125		
T <sub>C</sub>	Operating Case Temperature	-40		100		
Torque	Mounting torque	To Heatsink	M5	2.5	4.7	N.m
Wt	Package Weight				160	g

**Temperature sensor NTC** (see application note APT0406 on www.microsemi.com for more information).

Symbol	Characteristic	Min	Typ	Max	Unit
R <sub>25</sub>	Resistance @ 25°C		50		kΩ
B <sub>25/85</sub>	T <sub>25</sub> = 298.15 K		3952		K

$$R_T = \frac{R_{25}}{\exp\left[B_{25/85}\left(\frac{1}{T_{25}} - \frac{1}{T}\right)\right]}$$

T: Thermistor temperature  
 R<sub>T</sub>: Thermistor value at T

**SP4 Package outline** (dimensions in mm)

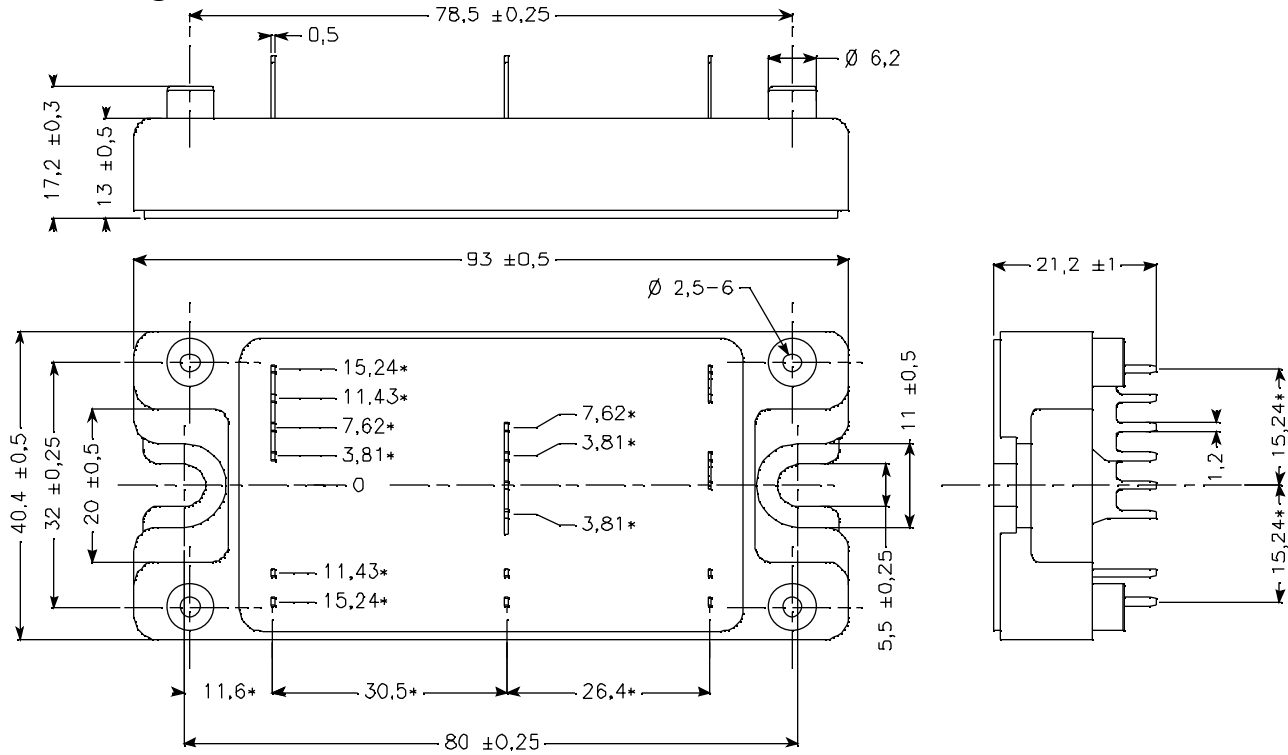

ALL DIMENSIONS MARKED "\*" ARE TOLERANCED AS :  $\varnothing \pm 0,1$

See application note APT0501 - Mounting Instructions for SP4 Power Modules on [www.microsemi.com](http://www.microsemi.com)

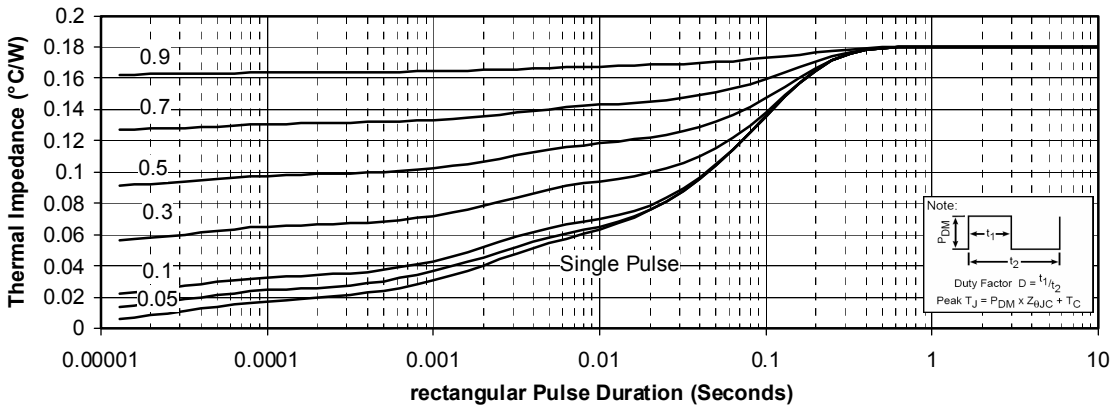
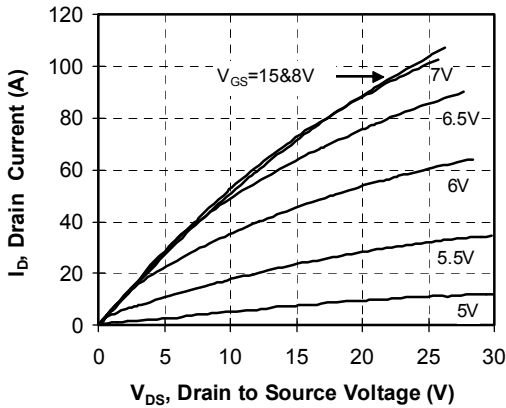
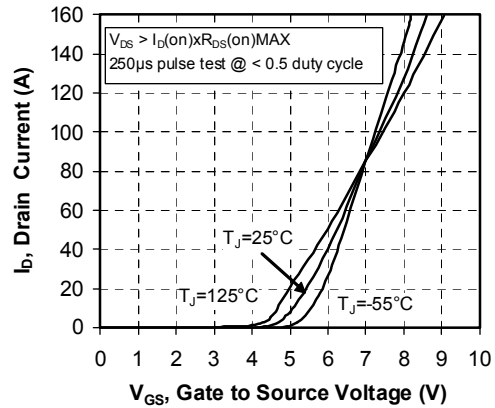
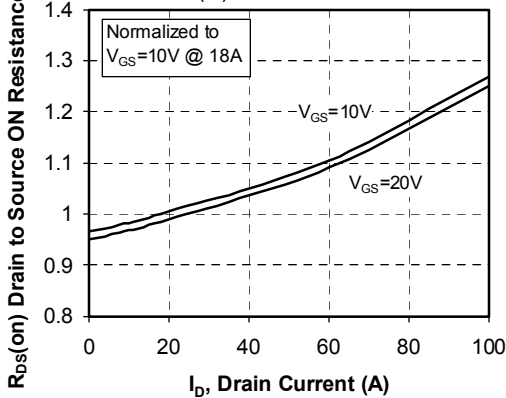
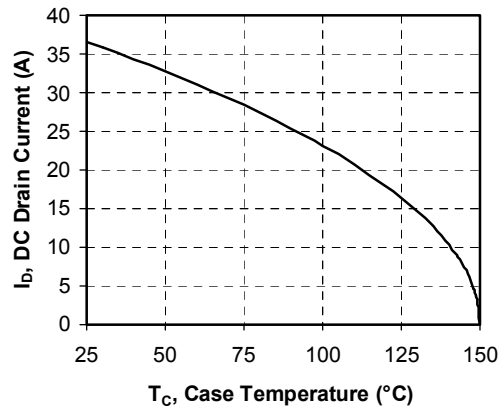
**Typical Performance Curve**
**Maximum Effective Transient Thermal Impedance, Junction to Case vs Pulse Duration**

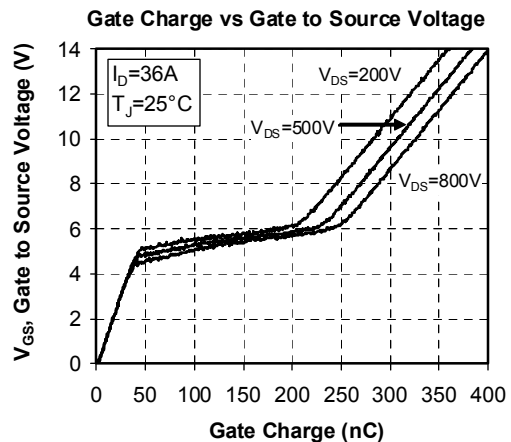
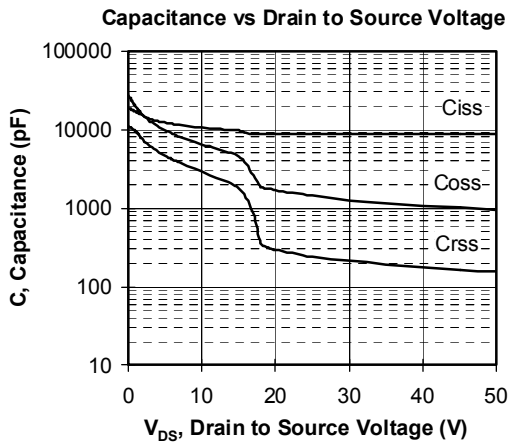
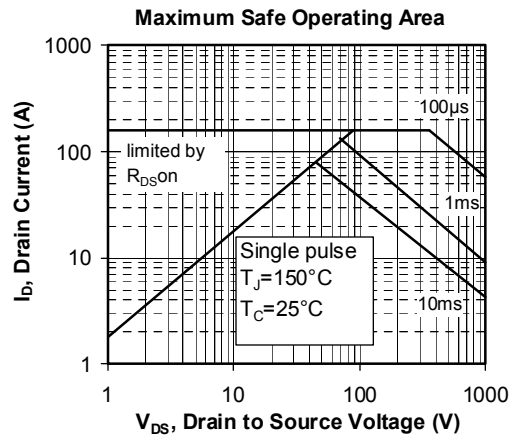
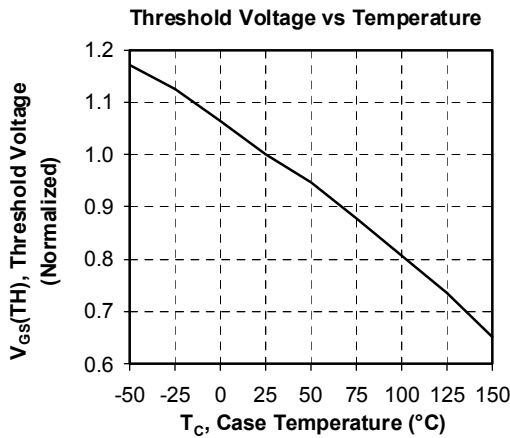
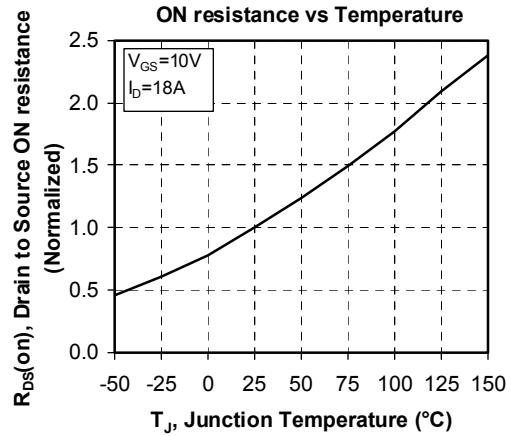
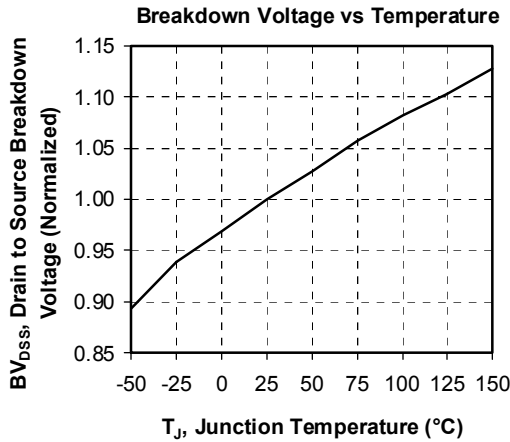
**Low Voltage Output Characteristics**

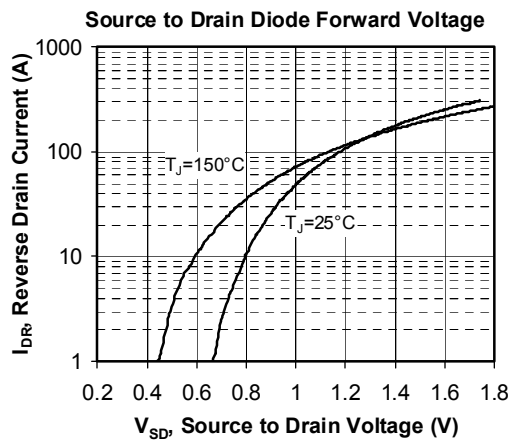
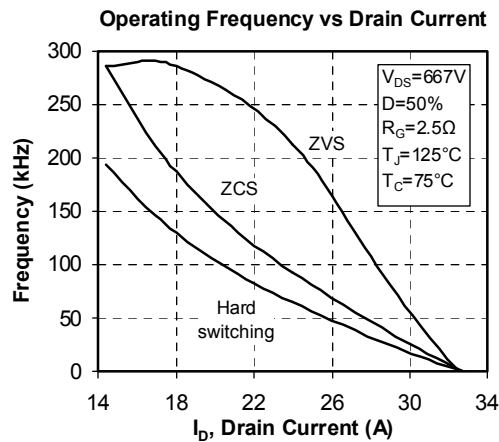
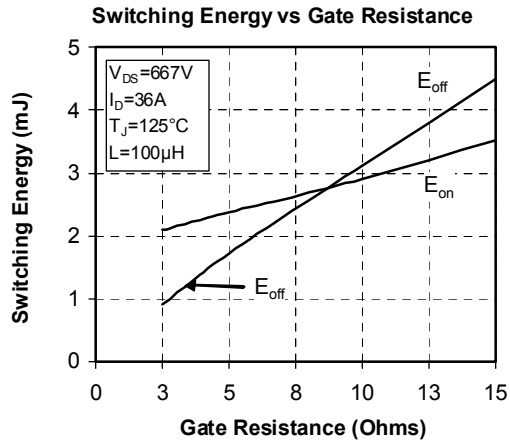
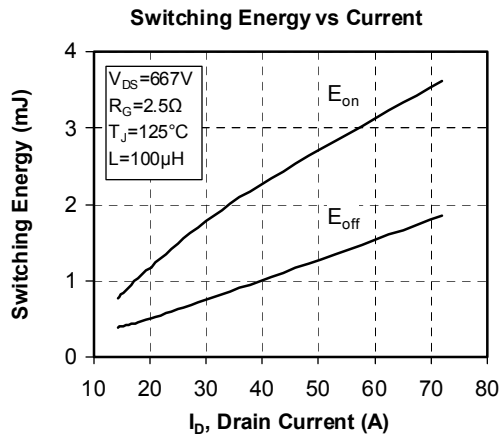
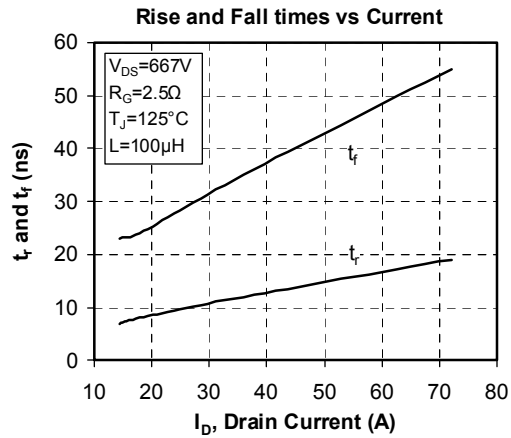
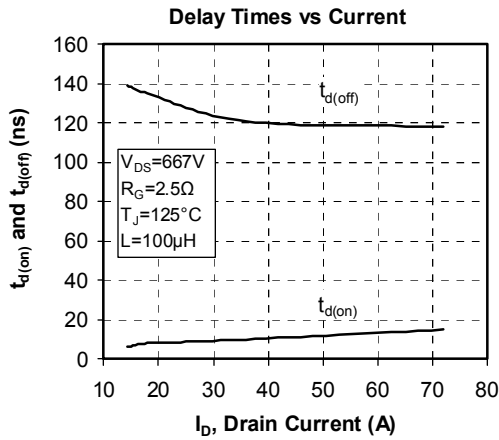
**Transfer Characteristics**

**R\_DS(on) vs Drain Current**

**DC Drain Current vs Case Temperature**





Microsemi reserves the right to change, without notice, the specifications and information contained herein

Microsemi's products are covered by one or more of U.S. patents 4,895,810 5,045,903 5,089,434 5,182,234 5,019,522 5,262,336 6,503,786 5,256,583 4,748,103 5,283,202 5,231,474 5,434,095 5,528,058 and foreign patents. U.S. and Foreign patents pending. All Rights Reserved.